



# HATO

THE NAME OF QUALITY

## **HATO 400Y**

AUTOMATION MANUAL  
FOR SLIDING GATES  
WITH SLOW DOWN



Congratulations on your purchase of a sliding gate controller and welcome to the users of HATO products. Declarations of conformity and manuals for HATO POLSKA S.C. products can be downloaded from the website: <http://www.hato.com.pl>

Before assembling and using the barrier for the first time, read the manual carefully and keep them for future reference.

In accordance with the provisions of the **Machinery Directive 2006/42 / WE**, it is declared that the product may not be put into operation until the final machine, into which it is built or a subassembly of which it is built, obtains a declaration of compliance with the directives and relevant regulations, which the final machine must meet.

## RECOMMENDATIONS AND PRECAUTIONS

Before installing and using the drive, carefully read all warnings and safety rules. Incorrect installation and non-compliance with the standards contained in the manual may result in serious accidents.

- All installation work should be carried out in accordance with applicable regulations and standards.
- The driver installation may only be performed by qualified and authorized personnel.
- Installation should be carried out with basic ESD protection.
- Be especially careful during assembly! The controller uses 230Vac voltage (life and health threatening).
- All works related to the proper functioning of the device (connection, start-up, operation) must be carried out in accordance with the applicable regulations in the field of electrical equipment operation and in accordance with health and safety regulations.
- Do not connect the drive to the power supply earlier than specified in the manual, failure to do so may result in electric shock.
- Before starting the installation, check the mechanical condition of the barrier: it should not sway excessively, it should move easily and smoothly.
- Before installation, remove unnecessary items and secure accessories, such as locks.
- During assembly, children, handicapped persons and motor vehicles must not be in the vicinity of the barrier.
- All fixed control elements should be located near the barrier, but away from moving parts and out of the reach of outsiders.
- Before repairing or removing any parts of the barrier, disconnect power. Children and people with intellectual disabilities cannot control the barrier on their own.
- Configuration of overload and thrust settings may only be performed by qualified personnel.
- Fluorescent lamps must not be used as traffic lights.

**This product may only be used for its intended purpose. Improper use is improper and dangerous. The manufacturer of the product is not liable for any damage caused by improper or negligent use.**

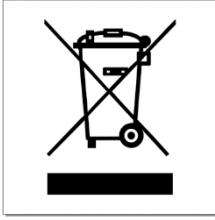

- Failure to follow the instructions above may result in serious injury or equipment damage. The manufacturer is not liable for damage and malfunctions resulting from failure to observe these installation and operating instructions.

In accordance with the regulations in force on the disposal of waste equipment by private users in the European Union, items bearing this symbol **MUST NOT** be disposed of with other rubbish. In this case, the user is responsible for proper disposal by delivering the device to a designated point, or to the manufacturer who will take care of its further disposal. Separate collection and recycling of unnecessary devices helps to protect the environment and ensures that disposal is done in a way that protects human health and the environment. This note also applies to waste batteries and accumulators.

RECOMMENDATIONS AND PRECAUTIONS.....	2
2. IMPORTANT SAFETY INSTRUCTIONS.....	4
DESCRIPTION AND PRINCIPLE	
OF THE OPERATION OF THE CONTROLLER.....	6
PURPOSE.....	6
CONTROLLER ADVANTAGES.....	6
DRIVER INSTALLATION.....	7
1.1.Connecting the limit switch for opening and closing.....	7
The limit switch for opening and closing is used to precisely stop the gate in the closed or open position. Adjust the position of the magnets so that the gate opens and closes accurately. ....	7
1.2.Connecting photocells.....	7
1.3.Connection of the manual control.....	8
1.4.Pulse generator connection - OPTIONAL.....	8
1.5.Capacitor connection.....	8
1.6.Motor connection.....	8
1.7.Connection of signal lighting .....	8
1.8.Power connection.....	8
CONNECTION DIAGRAM.....	9
SETTING PROGRAMMING.....	10
TRAFFIC LIGHTS.....	10
FLASHING ON / OFF (Default: enabled).....	10
AUTOCLOSE FUNCTION.....	11
ENGINE OPERATION PROGRAMMING.....	12
RESTORING DEFAULT SETTINGS - 60s operation without encoder and without deceleration .....	14

WICKET FUNCTION.....	14
OPEN ONLY FUNCTION.....	16
PHOTO CLOSE FUNCTION.....	17
LIMIT SWITCH TYPE.....	17
DELETING ALL TRANSMITTERS.....	17
PROGRAMMING OF TRANSMITTERS.....	18
TECHNICAL SPECIFICATION.....	19
DECLARATION OF CONFORMITY.....	19
.....	19
WARRANTY CONDITIONS.....	20

## **1. DESCRIPTION AND PRINCIPLE OF OPERATION OF THE DRIVE**

The HATO 400Y drive is designed for sliding gates. It has been equipped with an auto-reverse function, infrared sensors, partial opening (pedestrian crossing), mechanical unlocking enabling manual opening in the event of failure of the drive controller. The device consists of a single-phase motor and a worm gear. The main motor shaft rotates the worm, driving the worm gear and pinion, moving the rack attached to the gate, thereby causing it to shift. In the event of an electrical failure, you can release the motor lock and push the gate by hand. The device has a temperature sensor installed, which automatically turns off the engine at 120 ° C and turns it on when the temperature drops to 85 ° C +/- 5 ° C.

The applied system of rolling coding of Microchip remote controls makes the system unavailable to an unauthorized person.

## **2. IMPORTANT SAFETY INSTRUCTIONS**

The drive and the sliding gate should be installed in accordance with the instructions presented in Fig. 1. It is recommended to install stops at both ends of the gate to prevent it from falling out of the rails. The rails must be installed horizontally. To ensure adequate stability, the drive foundation should be made of concrete. Electric wires must be secured with a suitable installation pipe. If a hand switch is installed, use two pipes: one for the power cord and the other for the low voltage wire (to the button). The method of fastening the drive is shown in Fig. 2, the drive can be attached to the so prepared mounting base. Fix the rack to the gate with screws and adjust it so that it fits exactly with the pinion. The distance between the rail and the wheel should be approx. 0.5-1 mm.

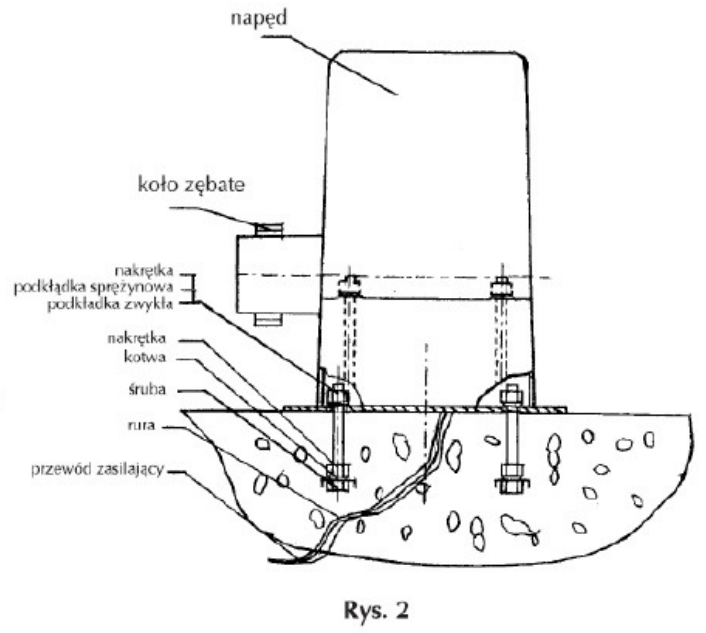
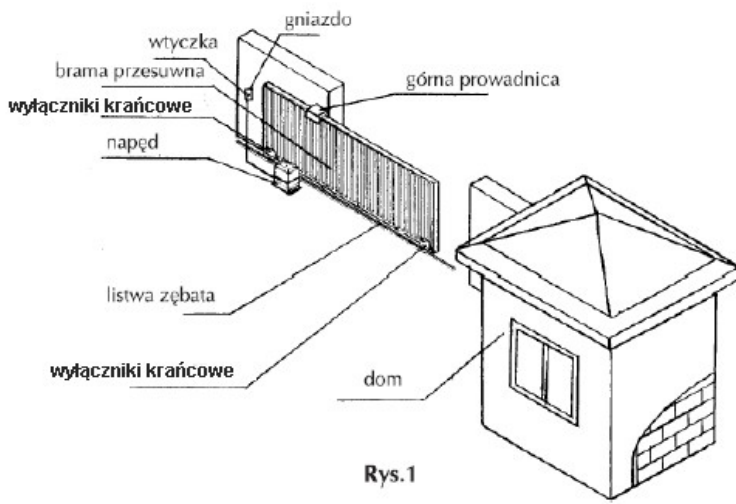

### 3. MOUNTING OF THE LIMIT SWITCH CAMS

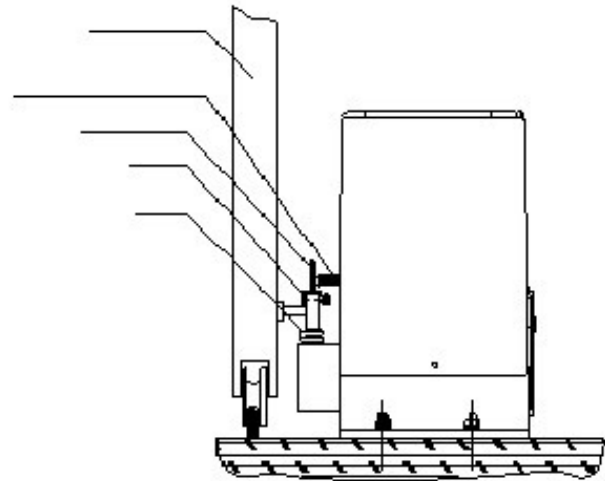

Fig. 3.



Fig. 4

The cams of the limit switch should be mounted on the toothed rack bar. They should be pre-installed in such a way that the beginning of pressure on the limit switch is about 10 cm before the complete opening (closing) of the gate. The exact setting is made after starting the drive.

## DESCRIPTION AND PRINCIPLE OF THE OPERATION OF THE CONTROLLER

### PURPOSE

The **HEL B11** controller is designed for gate drives using 230Vac motors with a power of up to 500W. Perfect for continuous operation, it can be used on private properties and in companies. The used system of variable coding of Microchip transmitters makes it unavailable to an unauthorized person.

### CONTROLLER ADVANTAGES

- Soft start function increasing the life of the door.
- Control by means of remote-control transmitters (up to 28 pcs.) On the frequency of 433.92 MHz with a dynamic Keeloq code.
- Control of the monostable button (bell type).
- **AUTO CLOSE** function.
- **ONLY OPEN** function (estate function).
- **WICKET** function.
- Adjustment of the thrust - when working with the encoder turned off.
- Overload control - when working with the encoder support turned on.
- Working time adjustment.
- A release function before reaching the limit switch
- Remote programming of engine operation (using transmitters).
- Traffic lights with flashing option.
- The function of shortening the auto-closing time after detecting a passage - PHOTO CLOSE.
- Support for NC and NO limit switches.
- Possibility to install an infrared barrier.

- Simple installation and programming procedure.

## MODE OF ACTION

The drive is controlled by the transmitter button programmed in **HELB11** or the **SBS** sequence control bell button. In the case of control from the **SBS** input or a transmitter assigned to this function, the operation consists in carrying out the step-by-step commands **OPEN-STOP-CLOSE-STOP** or with the **ONLY OPEN** function enabled, it is only possible to open the gate. After turning on the power, the first command is to open, if we give the next command while the gate is moving, we will stop it, and then we can run it in the closing direction. The **WICKET** function (partial opening) is controlled by a button on the transmitter assigned to this function.

Depending on the version, the controller works with motors with or without a built-in pulser. For the version with the pulse generator, it is also possible to disable its support during the engine operation programming procedure. The lighting of the ENCODER diode means that the operation is switched on.

### **ATTENTION!**

The pulser parameters must be consistent with the description in paragraph SOFTWARE for the appropriate version of the controller.

## DRIVER INSTALLATION



Before starting the installation, make sure that all safety recommendations are met.

Any installation work may only be performed by qualified personnel. Electrical installation and connection of electronic devices may only be performed by persons with appropriate electrical qualifications.

1. Turn off the power.
2. Install the controller mechanically.
3. Pull out the quick couplings.
4. Connect the cables to the quick couplers according to the description or connection diagram: (wires connected to quick couplers should be flexible - "cord")

### 1.1. Connecting the limit switch for opening and closing

The limit switch for opening and closing is used to precisely stop the gate in the closed or open position. Adjust the position of the magnets so that the gate opens and closes accurately.

<b>16</b>	<b>OL</b>	—opening	limit
<b>17 CL</b>	— closing limit switch,		
<b>18 COM</b>	— common cord		

The controller works with the normally open **NO** or normally closed **NC** type limit switches. The selection is made with the **NC / NO switch**.

- **NC/NO** from position **ON** –normally open **NO**
- **NC/NO** in position **OFF** –normally closed **NC**

### 1.2. Connecting photocells

The infrared barrier is an essential security element that must be connected to the controller. It prevents the gate from hitting a vehicle, person or object in its light. Photocells are

necessary for the correct operation of the device and ensure safety. If the encoder support is disabled, it is required to connect a safety curtain or other additional protection against crushing in the gate's light. They must be connected in series with the photocells

#### PHOTOCELL

**12 +24VDC** – photocells power supply plus

**13 COM** – photocells power supply minus

**13 COM** –COM output of the photocell

**14 FOTO** –NC contact of the photocell



***The power supply of the 24V connector is <450mA, therefore make sure that the total power load does not exceed this current value. An exemplary photocell connection diagram is shown in fig. 2.***

1.3.

#### Connection of the manual control

Connection of the manual control should be made with a 2x 0.5mm cable (the cable type should be in accordance with CEI 20-22; CEI EN50267-2-1 standards), the maximum length of the manual control cable depends on its electrical parameters, therefore it should be assumed the following rule that with the required cable length, its resistance should not exceed 100ohm. As a standard, the use of a cable with a cross-section of 0.5 mm and a length of not more than 20 m is sufficient for the correct operation of the controller, for required greater distances, 4x0.5 (mm) cables can be used by connecting the wires in parallel - in pairs, or by increasing the cross-section of the cable (2x 1mm).

**15 SBS** –bell button

**18 COM**

#### 1.4. Pulse generator connection - OPTIONAL

The controller supporting the pulser located on the engine has an ENCODER connector. The installation consists in connecting the wires to this connector.



***Next, make the electrical connections of the connector on the left side as shown in Fig. 2.***

1.5.

#### Capacitor connection

Connect a capacitor to connector numbers 9 and 10, polarity does not matter.

#### 1.6. Motor connection

The motor connection should be made in accordance with the description:

**7 COM** – common engine wire

**11 OPEN** – motor cable to activate it in the direction of opening

**8 CLOSE** – motor cable to actuate it in the closing direction

**1 PE** – PE protective conductor

1.7.

#### Connection of signal lighting

The light bulb with a power not exceeding 15W / 230V should be connected to connectors 5 and 6:

5 – the neutral wire of the lamp

6 – lamp phase wire



***When using the flashing light function, do not connect the signaling device with the built-in internal circuit breaker. This can damage the driver. When using a signaling device with a built-in circuit breaker, make sure that the light function is set to continuous mode before connecting it.***



***Fluorescent lamps must not be used as traffic lights.***

1.8.

#### Power connection



The last stage of connection is to connect the controller power supply. Connect in turn the wires:

- 2 PE –protective conductor
- 3 L –phase wire
- 4 N –neutral wire



*Protect the controller power supply by using a residual current circuit breaker.*

2. Put the quick couplers back into the controller.



*Before starting the device, check the power supply, grounding and wiring. The cables should not be too long, it is not allowed to wind the remaining cable in the so-called "Loops". The controller power, motor and control cables should be kept separate.*

3. Manually place the gate in the center.
4. Turn on the power.
5. Program the remote-control transmitters.
6. Check the opening direction.

The first pressing of the manual control button or the transmitter (which has been programmed) starts the door in the opening direction. Otherwise, swap the wires connected to the OPEN (11) and CLOSE (8) connectors (after disconnecting the power supply first).

7. Set potentiometer VR1 (turning clockwise increases the value, on the contrary reduces it) the engine's thrust (selected for the load in accordance with the applicable standards).



*The regulation should be carried out in accordance with the applicable standards.*

8. Program the remote control transmitters.
9. Program the engine operation - according to the procedure described in paragraph Programming.
10. For the motor with the pulse generator, adjust the sensitivity of overload detection with the VR2 potentiometer.



*The regulation should be carried out in accordance with the applicable standards.*

11. Check the correct operation of the entire automatic unit and all connected safety, signaling and control elements (limit switches, photocell, edge strip, light signaling etc.).
12. Set the available additional functions.
13. Train all users of the gate.

CONNECTION DIAGRAM

# SETTING PROGRAMMING

Programming the controller is done using the **SETUP**, **LEARN** buttons, **LED** and **ENCODER** diodes and 4 function switches located on the controller board.

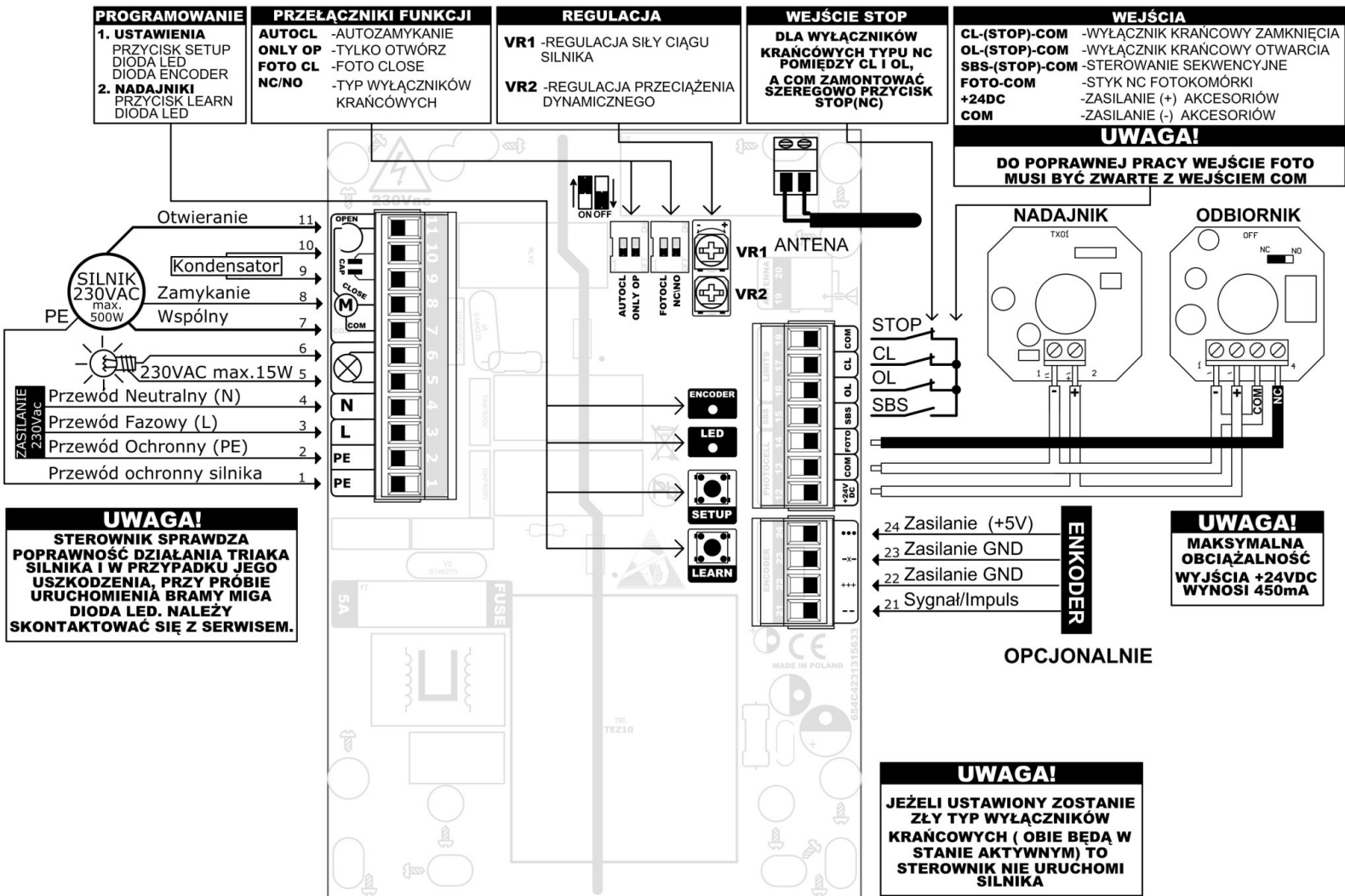

the controller will set the time to **0s**.

After **3s** from the last press, the **LED** will flash 3 times. The controller will remember the settings and return to normal operation.

Set the **AUTO CL** switch to the desired position.

## FLASHING ON / OFF (Default: enabled)

If the **AUTO CLOSE** function is enabled, set the **AUTO CL** switch to the **OFF** position.



Hold down the **SETUP** button for less than 3s. When the button is pressed, the **LED** lights up.



Release the **SETUP** button.



The **LED** will flash rapidly.

Hold the <b>SETUP</b> button again within 3 seconds. Pressing is signaled by continuous lighting of the diode.	
The <b>LED</b> will flash rapidly.	
Release the <b>SETUP</b> button.	
After releasing the button, the <b>LED</b> will show the current status of the function. The lighted on means the function is active, and the light off means the function is inactive.	
To change the state of the function to the opposite, press the <b>SETUP</b> button briefly within <b>3 seconds</b> .	
After <b>3s</b> from the last press, the <b>LED</b> will flash <b>3</b> times. The controller will remember the settings and return to normal operation.	

## AUTOCLOSE FUNCTION



When the gate stops, after the OPEN signal, the time set by the user is counted down, after which the CLOSING will take place. The light shines during the countdown. For the user's safety, photocells are required (so that the gate does not close when there is an obstacle in its light!). Additionally, when the **PHOTO CLOSE** function is on, the photocells will shorten the auto-closing time and after detecting the passage, the gate will close after 5 seconds. If less than 5s are left until automatic closing, each detected passage will cause the countdown of an additional 5s. If the gate is in the fully open position, each signal trying to activate it in the opening direction will start the countdown of the auto-closing time.

**ATTENTION! Stopping the gate with a transmitter or control button during closing stops the countdown. Therefore, to close the gate, press the control button again - you can use it when you need to leave the gate open for some time.**

To <b>turn on</b> the function, set the <b>AUTO CL</b> switch to the <b>ON</b> position.	
Set the desired auto-closing time according to the procedure.	<b>SETTING THE AUTO-CLOSING TIME</b>
To <b>disable</b> the function, set the <b>AUTO CL</b> switch to the <b>OFF</b> position.	

## SETTING THE AUTO-CLOSING TIME

We set it in the range from **15s** to **25min** with a step of 15s. By default: **6min**











The <b>AUTO CL</b> switch must be in the <b>ON</b> position.	
Hold down the <b>SETUP</b> button for less than <b>3s</b> . When the button is pressed, the <b>LED</b> lights up.	
Release the <b>SETUP</b> button.	
The <b>LED</b> will flash rapidly.	







<p>Within <b>5s</b>, start setting the time. Press <b>SETUP x</b> times. One press corresponds to <b>15s</b>. Each pressing is signaled by the lighting of the diode. If the button is not pressed within these <b>5 seconds</b>, the controller will set the default time.</p>	
<p>After <b>3s</b> from the last press, the <b>LED</b> will flash <b>3 times</b>. The controller will remember the settings and return to normal operation.</p>	

## ENGINE OPERATION PROGRAMMING

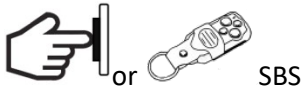
The maximum engine operation time is 2 minutes. The controller enables programming of the gate slowing down - during this time the motor works at a reduced speed, reaching the end position. Adjust the settings so that the motor slows down approx. 50 cm before the end position.







**DEFAULT SETTINGS:** 60s (without deceleration)

<p><b>ATTENTION!</b> The photocell input is ignored during the procedure. Adjust the thrust on the <b>VR1</b> potentiometer in accordance with the applicable standards.</p>	
<p>Hold down the <b>SETUP</b> button.</p>	
<p>The <b>LED</b> will turn on and then turn off.</p>	
<p>Release the <b>SETUP</b> button.</p>	
<p>If the gate is in the fully closed position, the <b>LED</b> will flash quickly and <b>items marked with asterisks * should be omitted</b>. If the gate is not fully closed, the <b>LED</b> will flash slowly.</p>	 
<p>Press shortly the <b>LEARN</b> button to set whether the motor has a built-in pulse generator.  Pressing the button changes the state of the function to the opposite. The lit <b>ENCODER</b> diode means that the pulser service is on, and the extinguished diode - it is off. <b>(For the driver version without encoder support, skip this point.)</b></p>	  <p>ENCODER</p> <p>ENCODER</p>
<p>* Press the <b>SBS</b> sequence control button for less than <b>3s</b> or the transmitter button assigned to the <b>SBS</b> function.</p>	 or  SBS
<p>* The gate starts to close (for work without the encoder with the power set on the potentiometer P). The <b>LED</b> will be on.</p>	
<p>* When the gate is fully closed, the <b>LED</b> will flash rapidly.</p>	

<p>Press the <b>SBS</b> sequence control button for less than <b>3s</b> or the transmitter button assigned to the <b>SBS</b> function.</p>	
<p>The gate will start to open (for work without an encoder with the power set on the P potentiometer). The <b>LED</b> will be on.</p>	<p>F% (M) OTWIERANIE</p>
<p>To define deceleration positions before full opening, press the <b>SBS</b> sequential control button for less than <b>3 seconds</b> or the transmitter button assigned to the <b>SBS</b> function.</p>	
<p>The gate will open at slow speed. The <b>LED</b> will be on.</p>	<p>L% (M) OTWIERANIE</p>
<p>Gate stops in the fully open end position. The <b>LED</b> will turn off.</p>	<p>(M) STOP OL</p>
<p>Press the <b>SBS</b> sequence control button for less than <b>3s</b> or the transmitter button assigned to the <b>SBS</b> function.</p>	
<p>The <b>LED</b> will blink 3 times to indicate that the time has been accepted, and then it will blink waiting for the closing direction settings.</p>	
<p>Press the <b>SBS</b> sequence control button for less than <b>3s</b> or the transmitter button assigned to the <b>SBS</b> function.</p>	
<p>The gate will start to close (for work without an encoder with the power set on the <b>VR1</b> potentiometer). The <b>LED</b> will be on.</p>	<p>F% (M) ZAMYKANIE</p>
<p>To determine deceleration positions before full closure, press the <b>SBS</b> sequential control button for less than <b>3s</b> or the transmitter button assigned to the <b>SBS</b> function.</p>	
<p>The gate will close at slow speed. The <b>LED</b> will be on.</p>	<p>L% (M) ZAMYKANIE</p>
<p>Gate stops in the fully closed end position. The <b>LED</b> will turn off.</p>	<p>(M) STOP CL</p>
<p>Press the <b>SBS</b> sequence control button for less than <b>3s</b> or the transmitter button assigned to the <b>SBS</b> function.</p>	
<p>The <b>LED</b> will blink <b>3</b> times to confirm that the settings have been saved. The controller will return to normal operation.</p>	
<p><b>ATTENTION!</b> To return to the normal operation without saving the settings, press the <b>SETUP</b> button for less than <b>3 seconds</b>. The gate will stop and the <b>LED</b> will blink once.</p>	 (M) STOP
<p><b>ATTENTION!</b> If you do not want to use the deceleration function, during programming, when the motor is</p>	<p>F% (M) <del>OL</del> (M) STOP OL/CL</p>

running in a given direction, do not press the <b>SBS</b> button and wait until the gate reaches its end position.	
<b>ATTENTION!</b> After each motor power adjustment on the <b>VR1</b> potentiometer, the motor operation programming procedure must be repeated.	ENGINE OPERATION PROGRAMMING
For work with encoder support, adjust the overload with the potentiometer <b>VR2</b> , in accordance with the applicable standards.	



### RESTORING DEFAULT SETTINGS - 60s operation without encoder and without deceleration











Hold down the <b>SETUP</b> button.	
The <b>LED</b> will turn on and then turn off.	
Release the <b>SETUP</b> button.	
If the gate is in the fully closed position, the <b>LED</b> will flash quickly, and if it is in another position, it will flash slowly.	 
Hold down the <b>SETUP</b> button.	
The <b>LED</b> will blink 3 times.	
Release the <b>SETUP</b> button. The controller will return to normal operation.	

### WICKET FUNCTION

It allows the door to be partially opened to the programmed width using the remote controls assigned to this function. The opening width can be programmed. With the **PHOTO CLOSE** function active, when an obstacle appears in the opening of the photocells, the gate will stop. It can be closed by pressing the manual control button or the remote-control transmitter. In conjunction with the **AUTO-CLOSE** and **PHOTO CLOSE** functions enabled during opening, when an object appears in the light of the photocells, the gate will stop, and when the object is removed, it will automatically close after **5 seconds**.

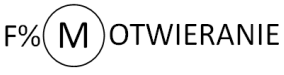



### ADJUSTING THE WIDTH OF THE GATE OPENING

Hold down the <b>SETUP</b> button.	
The <b>LED</b> will turn on and then turn off.	
Release the <b>SETUP</b> button.	

<p>If the gate is in the fully closed position, the <b>LED</b> will flash quickly and items marked with asterisks * should be omitted.</p>	
<p>* If the gate is not fully closed, the LED will flash slowly.</p>	
<p>* Press the <b>SBS</b> sequence control button for less than <b>3s</b> or the transmitter button assigned to the <b>SBS</b> function.</p>	
<p>* Brama zacznie się zamykać. Dioda <b>LED</b> będzie świecić.</p>	
<p>* The gate will start to close. The <b>LED</b> will be on.</p>	
<p>Press the <b>SBS</b> sequence control button for less than <b>3s</b> or the transmitter button assigned to the <b>SBS</b> function.</p>	
<p>The gate will begin to open. The <b>LED</b> will be on.</p>	
<p>To designate the stop positions, press the <b>SBS</b> sequence control button for less than <b>3s</b> or the transmitter button assigned to the <b>SBS</b> function.</p>	
<p>The gate will stop. The <b>LED</b> will turn off.</p>	
<p>Press the <b>SBS</b> sequence control button for less than <b>3s</b> or the transmitter button assigned to the <b>SBS</b> function.</p>	
<p>The <b>LED</b> will blink <b>3 times</b> to confirm that the settings have been saved. The controller will return to normal operation.</p>	
<p><b>ATTENTION!</b> To return to the normal operation without saving the settings, press the <b>SETUP</b> button for less than <b>3 seconds</b>. The gate will stop and the <b>LED</b> will blink once.</p>	
<p><b>ATTENTION!</b> After each adjustment of the motor power on the <b>VR1</b> potentiometer, the procedure of programming the door opening width should be repeated.</p>	

## SWITCHING OFF THE WICKET FUNCTION

<p>Hold down the <b>SETUP</b> button.</p>	
<p>The <b>LED</b> will turn on, then turn off and on again.</p>	

Release the <b>SETUP</b> button.	
If the gate is in the fully closed position, the <b>LED</b> will flash quickly, and if it is in another position, it will flash slowly.	 
Hold down the <b>SETUP</b> button.	
The <b>LED</b> will blink 3 times.	
Release the <b>SETUP</b> button. The controller will return to normal operation.	



## RUN TIME

During normal operation, the gate moves at full speed and in the deceleration position, the motor power is cut off for the programmed coast down time (to take into account the inertia), and then it moves at a slow speed. If there is a jerk effect when changing the speed from full to slow, the coasting time should be corrected.

### ATTENTION!

*The overrun time has an influence on the deceleration position and must be programmed before programming the motor operation, or after changing a parameter, retry the learn procedure.*

**We set it in the range from 0.1s to 1s with 0.1s step. Default: 0.3s**

Przytrzymaj przycisk <b>SETUP</b> .	
The <b>LED</b> will turn on, turn off, turn on and turn off again.	
Release the <b>SETUP</b> button.	
The <b>LED</b> will flash rapidly.	
<p>Within <b>5s</b>, start setting the time.</p> <p>Press <b>SETUP x</b> times. One press corresponds to <b>0.1s</b>. Each pressing is signaled by the lighting of the diode. If the button is not pressed within these <b>5s</b>, the controller will set the default time of <b>0.3s</b>.</p>	
After 3s from the last press, the <b>LED</b> will flash <b>3 times</b> . The controller will remember the settings and return to normal operation.	

## OPEN ONLY FUNCTION

It facilitates entry-exit communication by ensuring that the gate does not close when another person activates the gate using a manual control button or a remote control. **This function only works with AUTO CLOSE enabled.**

To **enable** the function, set the **AUTO CL** and **ONLY OP** switches to the **ON** position.



To <b>disable</b> the function, set the <b>ONLY OP</b> switch to the <b>OFF</b> position.	
---	--

### PHOTO CLOSE FUNCTION

Enables the gate to close faster and saves energy. During **opening**, after activation of the photocells, the gate will stop and with **AUTO CLOSE** enabled, after detecting a passage, the auto-closing time is shortened and the gate will close after **5 seconds**.

To <b>turn on</b> the function, set the <b>PHOTO CL</b> switch to <b>ON</b> .	
To <b>disable</b> the function, set the <b>PHOTO CL</b> switch to <b>OFF</b> .	





### LIMIT SWITCH TYPE

The controller works with both normally open and normally closed limit switches. The supported type is selected with a switch labeled **NC / NO**.

For <b>NO</b> type limit switches, set the <b>NC / NO</b> switch to the <b>ON</b> position.	
For <b>NC</b> type limit switches, set the <b>NC / NO</b> switch to the <b>OFF</b> position.	

### DELETING ALL TRANSMITTERS

When the memory is full or we have problems with programming the transmitters, we must perform the deletion procedure. We recommend that you perform this procedure first right after installing the receiver.

Hold down the <b>LEARN</b> button.	
The <b>LED</b> will turn on, then turn off and flash.	
Release the <b>LEARN</b> button. The <b>LED</b> will be on.	
Within <b>3 seconds</b> , hold the <b>LEARN</b> button again.	
The <b>LED</b> will blink <b>3 times</b> .	
Release the button. The deletion procedure is complete. When the diode stops blinking, the receiver will return to normal operation.	

### DELETING TRANSMITTERS FROM A PARTICULAR FUNCTION

It is possible to delete transmitters only from a particular function (**SBS** or **WICKET**).

Enter the procedure for programming the transmitters for the given function.	TRANSMITTER PROGRAMMING PROCEDURE
While waiting for the transmitter code, press and hold the <b>LEARN</b> button.	
The <b>LED</b> will blink 3 times.	





Release the button. When the diode stops blinking, the deletion procedure is finished and the controller will return to normal operation.



## PROGRAMMING OF TRANSMITTERS



A maximum of **28** transmitters with a Keeloq dynamic code can be programmed. Each button must be learned separately. It is possible to change the buttons controlling a given function of an already programmed transmitter by re-programming another button. When programming changes, remember that when programming for a given function, a button that has not been programmed will replace the button previously programmed in that function. A button previously programmed to one function, after being programmed to another, only works in the other function.



### Programming the transmitter for the SBS sequence control function.

Hold down the <b>LEARN</b> button for less than <b>3s</b> .	
The <b>LED</b> will flash rapidly.	
Press the transmitter button within <b>10 seconds</b> .	
Correct programming will be signaled by the <b>LED</b> blinking three times. 2 blinks indicate full memory. 1 blink means the end of the learning time.	
After correct programming, we have another <b>10s</b> to program the other transmitters, etc.	
To finish the procedure, wait <b>10 seconds</b> from the last programming or shortly press the <b>LEARN</b> button. <b>LED</b> will blink and the receiver will return to normal operation.	

### Programming the transmitter for the WICKET function

It allows the gate to be opened to the set width. With the **PHOTO CLOSE** function active, when an obstacle appears in the opening of the photocells, the gate will stop. It can be closed by pressing the manual control button or the remote control assigned to this function. In conjunction with the **AUTO-CLOSE** and **PHOTO CLOSE** functions enabled, during opening, when an object appears in the light of the photocells, the gate will stop, and when the object is removed, it will automatically close after 5 seconds.

Hold down the <b>LEARN</b> button.	
The <b>LED</b> will turn on and then turn off.	
Release the button.	
The <b>LED</b> will flash rapidly.	

Press the transmitter button within <b>10 seconds</b> .	
Correct programming will be signaled by the <b>LED</b> blinking three times. 2 blinks indicate full memory. 1 blink means the end of the learning time.	
After correct programming, we have another <b>10s</b> to program the other transmitters, etc.	
To finish the procedure, wait <b>10 seconds</b> from the last programming or shortly press the <b>LEARN</b> button. <b>LED</b> will blink and the receiver will return to normal operation.	

#### TECHNICAL SPECIFICATION

	<b>400Y</b>
Supply voltage	AC 230V 50Hz
Motor power	160 W
Engine speed	1400 rpm
Travel speed	12 m/min.
Output torque	10 Nm
Gate weight	do 600 kg
Noise level	< 62 dB
Auto-closing time	5s-10min
Continuous operation time max.	120s
Control board	HEL11:8.2.2
Standby power consumption	< 4,5 VA
Remote control type: E Keeloq version	HP-001* (1 piece)
Remote control operating frequency	433,92 MHz (with rolling code)
Min. Range of the remote control in open area	30 m
Remote control battery type	Typ 23A 12V
Memory of transmitters	28 pcs
Fuse type	5A/230V, ø5x20
Operating temperature range	-40 ; +70
Dimensions (length x height x width)	263 mm x 215 mm x 270 mm

\* the manufacturer reserves the right to change the remote control attached to the drive set

#### DECLARATION OF CONFORMITY

The HATO 400Y drive meets the requirements of the following regulations:  
Complies with the conditions of the Machinery Directive 2006/42 / EC Annex II Section B as amended.

Complies with the conditions of the following EU directives:  
Directive on electromagnetic compatibility EMC 2014/30 / EU  
Low Voltage Directive LVD 2014/35 / EU

The following harmonized standards have been applied:

the current declaration can be downloaded from the manufacturer's website [www.hato.com.pl](http://www.hato.com.pl)

#### DEAR CUSTOMERS

*Thank you for purchasing a HATO product and congratulations on your choice. We guarantee the efficient operation of the device covered by this warranty in accordance with the technical and operating conditions described in the manual. At the same time, we would like to remind you that the installation carried out in accordance with the assembly instructions, proper use in accordance with the instructions for use and carrying out the obligatory maintenance inspections in accordance with the instructions, ensure trouble-free operation of the device.*

### WARRANTY CONDITIONS

1. The Seller provides a guarantee for a period of 24 months - but not longer than 27 months - from the date of sale by HATO. The seller of the device is the performer of the warranty services (guarantor). Defects revealed during this time will be removed free of charge. The repair will be made as soon as possible, not exceeding 14 days from the date of delivery of the device to the HATO POLSKA Service Center. The guarantor reserves the right to extend the above period in justified cases.
  - 1.1. The condition for the validity of the 24-month warranty period is the performance by HATO Polska or its Commercial Partner of one paid inspection between 10 and 12 months from the date of purchase of the product by the User, which must be confirmed by an appropriate entry in the warranty card.
  - 1.2. In the absence of inspection, the warranty ends 12 months from the date of sale.
  - 1.3. The list of Business Partners can be checked at: [www.hato.com.pl](http://www.hato.com.pl) or by calling 32 785 25 42
2. A warranty repair is understood as the performance of specialized activities aimed at removing a defect in a device covered by the warranty. According to the opinion of the HATO service, the device or components, in which material, construction or production defects are found, and therefore malfunctioning, will be repaired or replaced with a defect-free device. The replaced parts become the property of the seller after servicing. The condition for the use of this warranty is:
  - 2.1. Presentation of the correction of the completed warranty card (seller's stamp, serial number of the device, date of sale, sales document number, buyer's data, date and place of installation, buyer's signature)
  - 2.2. Description of the product defect and a written complaint notification to the seller
  - 2.3. Attaching a valid purchase document (applies to products to which the warranty card is not attached)
3. The warranty does not cover:
  - a) mechanical, thermal, chemical and any other damage caused by the user's actions or omissions or external force (e.g. atmospheric phenomena, surges or electrical disturbances, electromagnetic disturbances)
  - b) damage caused by:
    - improper installation (inconsistent with the installation manual) and non-compliant use
    - intended use or the instruction manual, design changes and modifications made by the user and third parties
    - using malfunctioning or damaged products
    - using non-original spare parts or accessories other than HATO
    - too much work
  - c) damage to devices previously dismantled or repaired by unauthorized persons
  - d) devices with a damaged, illegible, incorrectly filled in warranty card or a broken seal
  - e) damage to devices used intensively and not subject to the required periodic inspection by the installer or other authorized company (the fact of the inspection and the scope of the maintenance activities carried out must be recorded in the warranty card)
  - f) replacement of parts with a specified lifetime that are subject to wear and tear during normal use: batteries, accumulators, bulbs, fuses
  - g) maintenance
  - h) devices where the serial number has been removed, damaged or changed

4. In the event of 4 unsuccessful warranty repairs, generally considered essential, the buyer has the right to replace the goods with a new one, free from defects. If you purchase several devices in one set, the possibility of replacement applies only to the device, the repairs of which have been unsuccessful four times.
5. The buyer is obliged to notify the seller about the defect within 2 days from the date of its disclosure
6. This warranty covers only HATO products installed and used in Poland
7. An unfinished and / or non-stamped warranty card is invalid
8. The warranty does not cover the costs of disassembly, reassembly and commissioning of the product as well as transport to the HATO service.
9. NOTE! The guarantee becomes void if the machine is installed by unauthorized persons.

Pieczęć HATO  
Data zakupu i nr seryjny urządzenia, potwierdzające legalność pochodzenia

Data sprzedaży, nr faktury, pieczęć i podpis sprzedawcy

--	--

Imię i nazwisko kupującego, adres zamieszkania

Podpis klienta

--	--	--

Data montażu

Miejsce montażu

Montaż i uruchomienie wykonane przez: (nazwa firmy oraz osoby uprawnionej lub nr uprawnień elektrycznych)

## KARTA PRZEGLĄDÓW OKRESOWYCH I NAPRAW

Data	Zakres przeprowadzonych prac konserwacyjnych/napraw	Pieczęć firmy, podpis uprawnionego pracownika

ul. Tunelowa 57  
40-676 Katowice  
POLAND  
tel. 032-785-25-42  
[www.hato.pl](http://www.hato.pl)

Magazyn i sprzedaż;  
ul. Żeromskiego 1  
41-205 Sosnowiec

[www.hato.com.pl](http://www.hato.com.pl)

**DISTROBUTOR/SELLER**